

Poptropica

Ultimate Coloring and Activity Book



Poptropica fun
and games across
the years and
across the classic
islands!

I = R

Assembled by
Invisible Ring



IMPORTANT: There are secret messages throughout this book, and the decoder key is nearby. Find it, and assemble this decoder to solve the clues!

Poptropica

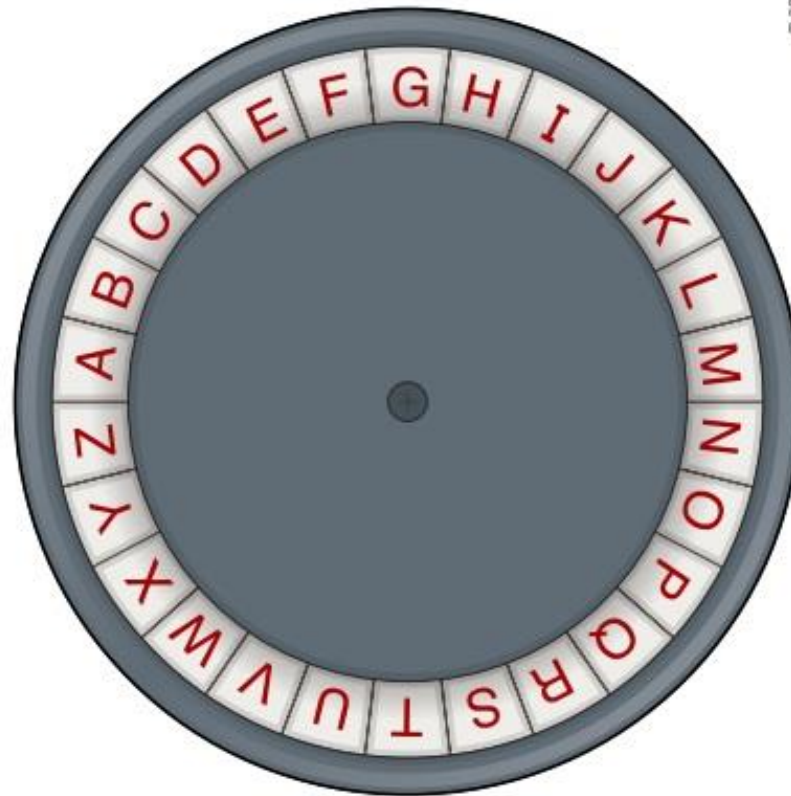
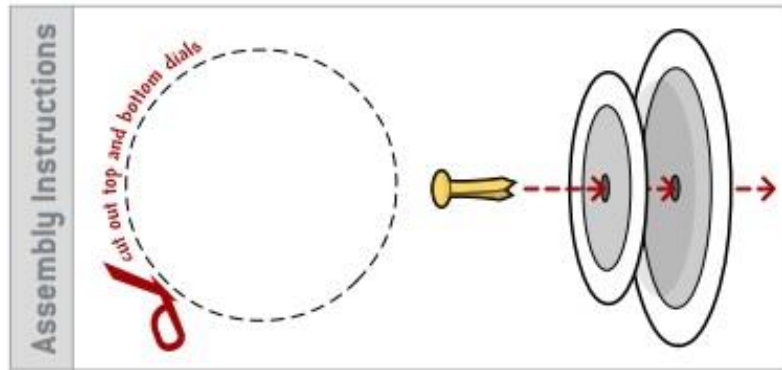

© 2000 - 2008 Pearson Education, Inc. All rights reserved

(But if you have no scissors or tape with you to assemble the decoder, don't fret. There's much more to do in this book! Just grab your pencils and crayons, and it's instant boredom buster time!)

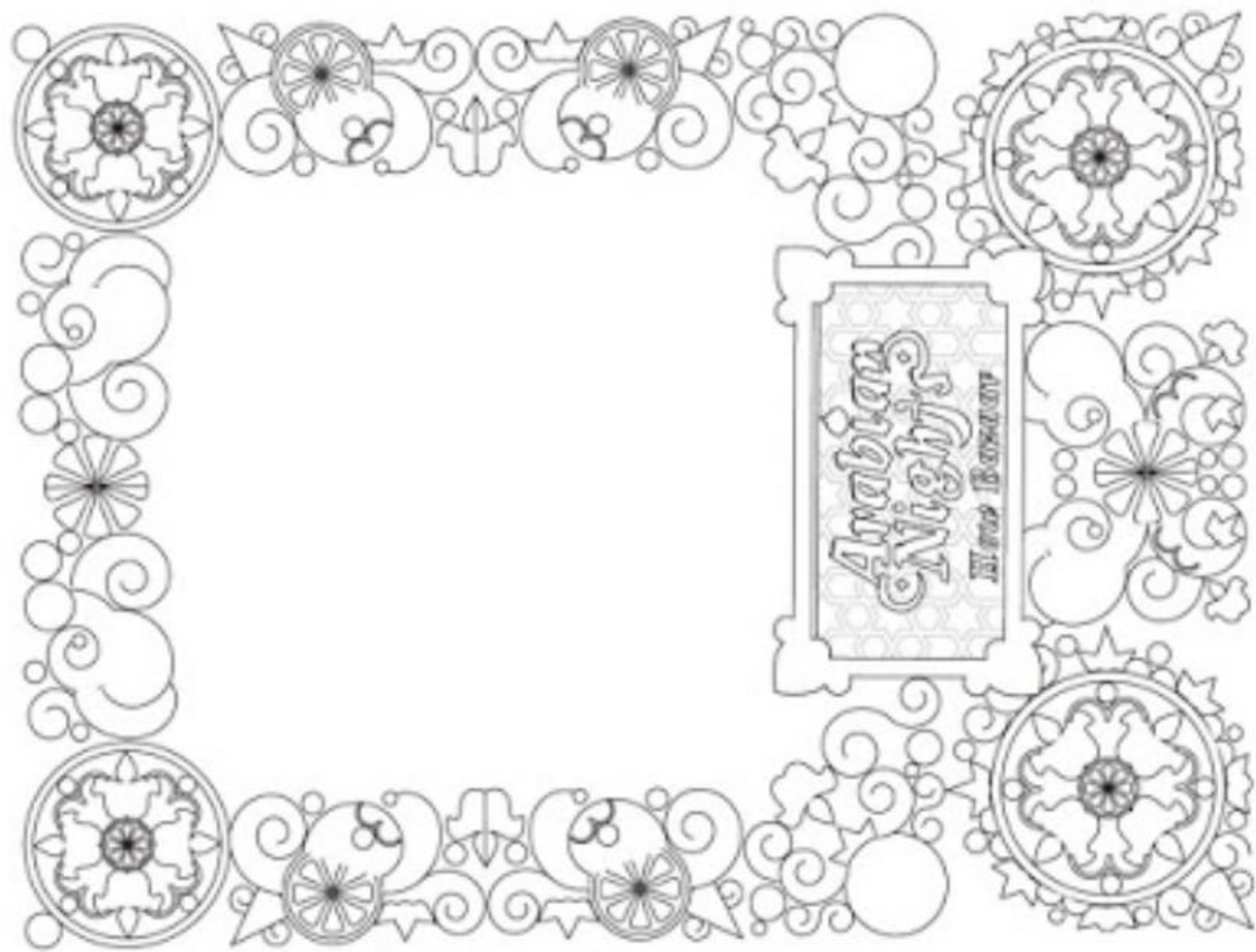



Arabian
Nights
How Bazaar



Arabian
Nights
How Bazaar

Poptropica

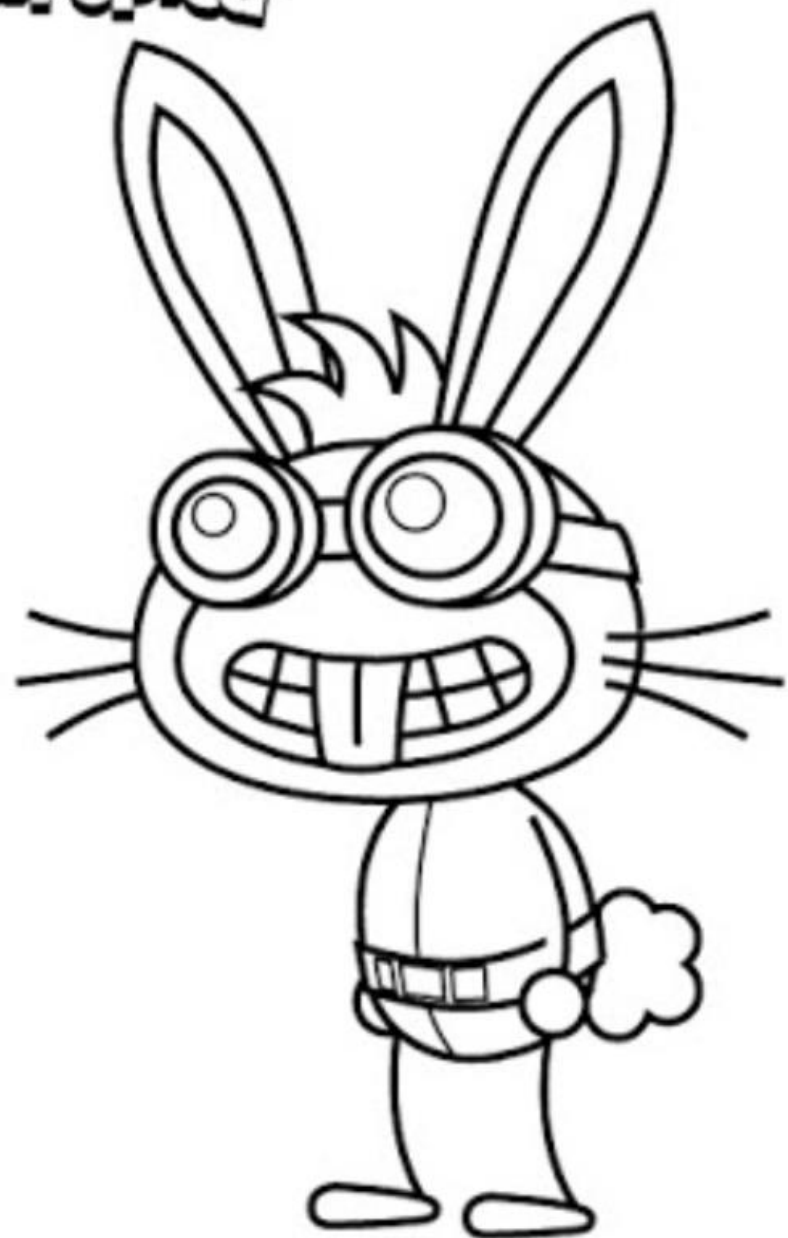

Arabian
Nights
How Bazaar



MAD LIBS

TOP 5 SIGNS A HOUSE IS HAUNTED

Is that creepy house just old and _____—or is it actually haunted? Here's how to tell:

1. It's located near a/an _____ graveyard where there are _____ tombstones of local legends like _____ and Will B. Haunten. There are also black _____ flying around, and a statue of a crying _____ with wings.
2. Old-fashioned portraits of _____'s family members hang on the walls, and their _____ appear to follow your every move.
3. A ghostly _____ drinks from a bowl of _____, eight-legged _____ scurry around, and a pot of _____ with _____ eyeballs boils on the stove.
4. The suit of knight's armor hands you its shield and _____ when you walk by.
5. You hear the cackle of a/an _____ or the rattle of a skeleton's _____, and a/an _____ chill runs up your _____!

For tons more MAD LIBS fun, go to www.madlibs.com!

Poptropica **MAD LIBS** AVAILABLE
NOVEMBER 8th

Star Link

You and your friend each grab a color and take turns drawing one line between any 2 adjacent stars (horizontally or vertically; not diagonally) to form boxes. Every time someone completes a box, they get to color it in and take an extra turn. The player with the most boxes of their color wins!

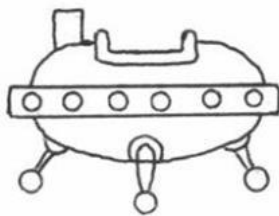
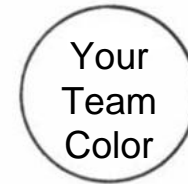

Draw your space cadet and color your ship

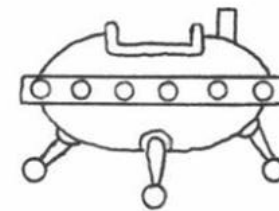

Draw your space cadet and color your ship

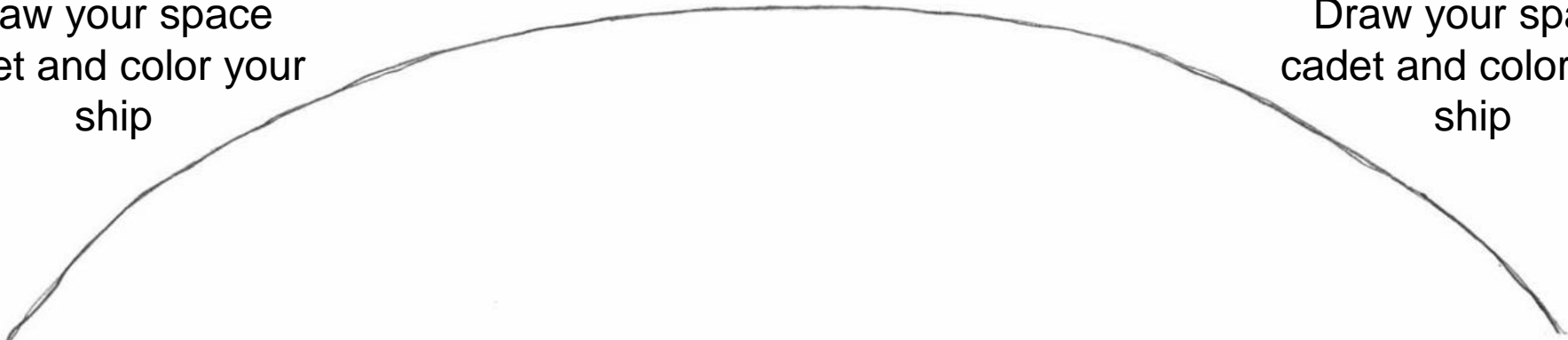

Dr. Hare's Corner

Color the funny bunny and share these jokes and poems to your friends and family!

Some say the world will end in fire,
Some say in ice.
From what I've tasted of desire
I hold with those who favor fire.
But if it had to perish twice,
I think I know enough of hate
To say that for destruction ice
Is also great
And would suffice.

- **Fire and Ice,**
By Robert Frost

ZEMZJZSCV
IZEX ZJ J
XVEZLJ! ...And I
should know!

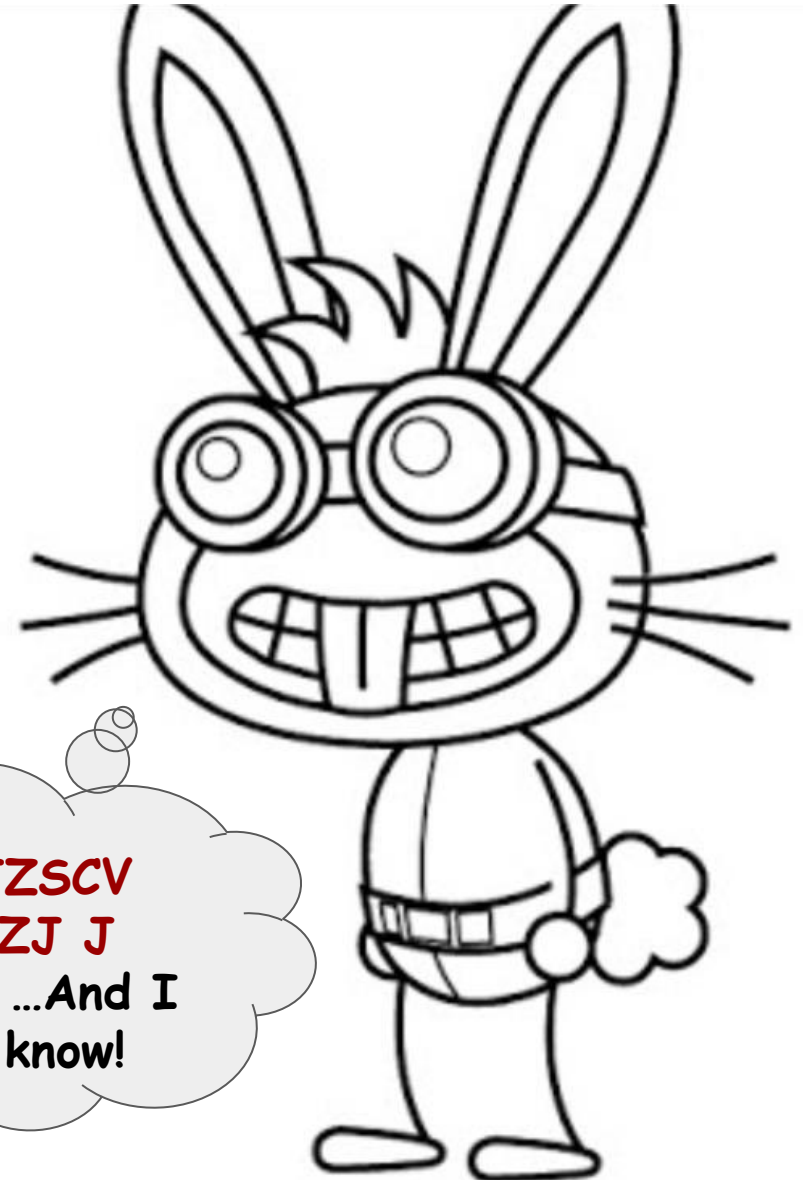



Poptropica®



Poptropica®



WORD SEARCH

Y L S M A Z Y G C V J S P W D D A C X S
G S N F O N A V U P P O P V V O K A Y S R R R E J P O J
T A A A P W I T L R E P P A T N R I F C S L V
J A G O B K U L O Q A P Q W R Z O J E H R B B Y
U V L Q E O A P R W L Z F C X X D Q S I O C G A E
T W L E V B I C Q Y U O A R W Y L O N C L V L K H K
F W M V I C Q Y U O A R W Y L O N C L V L K H K
Z P J A I C Q Y U O A R W Y L O N C L V L K H K
F J A I C Q Y U O A R W Y L O N C L V L K H K
I C S A F Y G T O J R W I S H O L G B D I J O
Y P T M N U A B H V I V A L P S L A L W L I M C F
B I L F O A B H V I V A L P S L A L W L I M C F
U S L M V I V A L P S L A L W L I M C F
S U R V I V A L P S L A L W L I M C F
T O B B A R I V T L A L W L I M C F
S E R U T N E V F R H S S G M C
D Z C J S L F R H S S G M C
A K F T M V W H S S G M C
U F N C D E L S S G M C

ADVENTURE
AMELIA
BLIMP

CARROTS
DRHARE
FREMULON

ISLANDS
MEDALLION
POPTROPICA

POPTROPICON
RABBOT
SNAGGLEMAST

SURVIVAL
WHISKERS



SECRET MESSAGE

You can make your own **LHNIPHKWL**
ZTFX. Just draw a circle around
the word searches to get started.

...Then see how many words you and
each of your friends can find!

-Write your decoded message on this page! →

Use your
Spy Island
decoder to
decode the
secret
message!

Key: B = I



Balloons

Balloons can float anywhere in this game! Find a friend and take turns drawing a balloon in any square you want. Be the first to get a horizontal, vertical, or diagonal 4-in-a-row and win! (Think of it like a giant tic-tac-toe game.)

Pick a color to play with and color your balloon

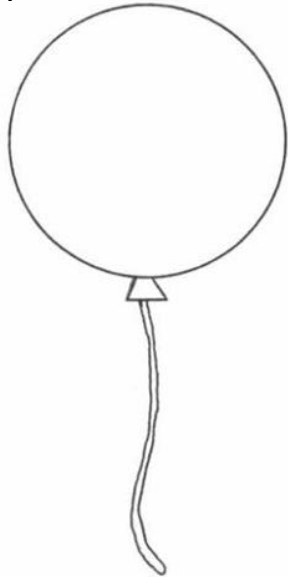

Pick another color to play with and color your balloon

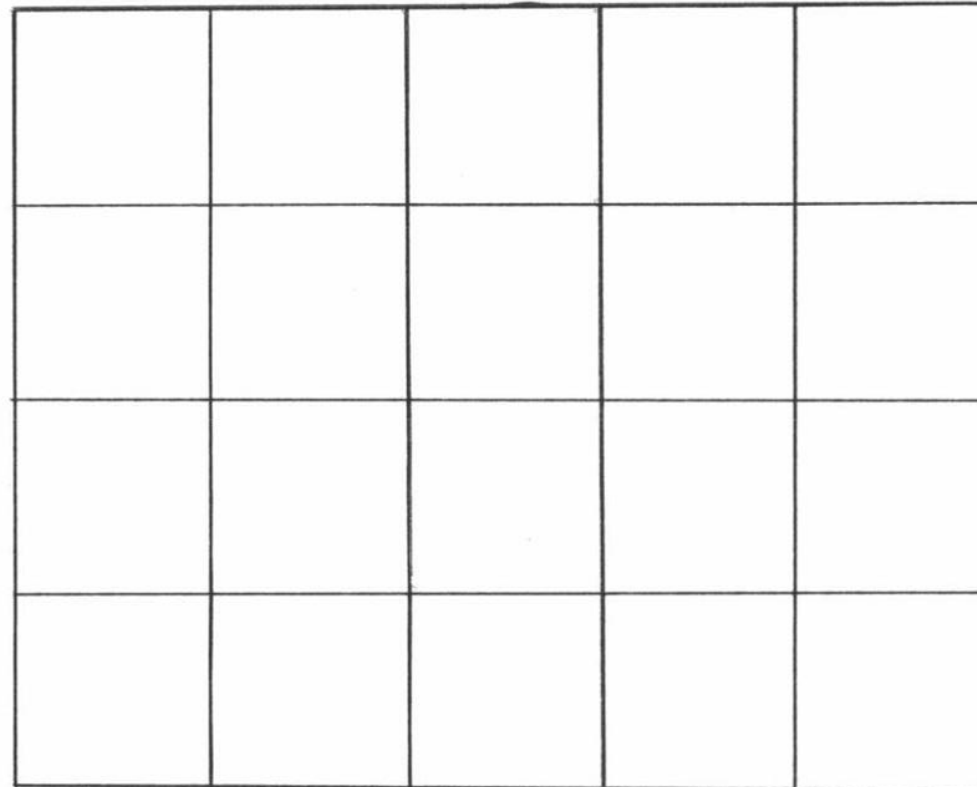
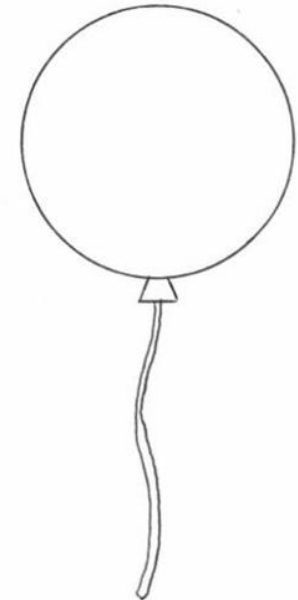

LG LG REU RNRP!

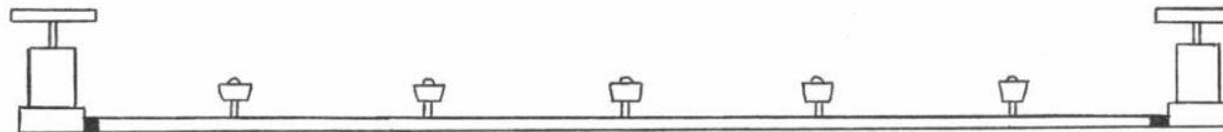

Draw your player here.

Draw your player here.

Dr. Hare's Corner

Color the funny bunny and share these jokes and poems to your friends and family!

Q: Knock Knock!

A: Who's there?

Q: Watson!

A: Watson who?

Q: Watson TV today?

Q: What time is it when a seagull flies over your head?

A: Time to get a new hat! BWAA ha ha!

Q: What time is it when a giant rabbit lands on your house?

A: Time to run, or else you're next! BWAA Ha ha!

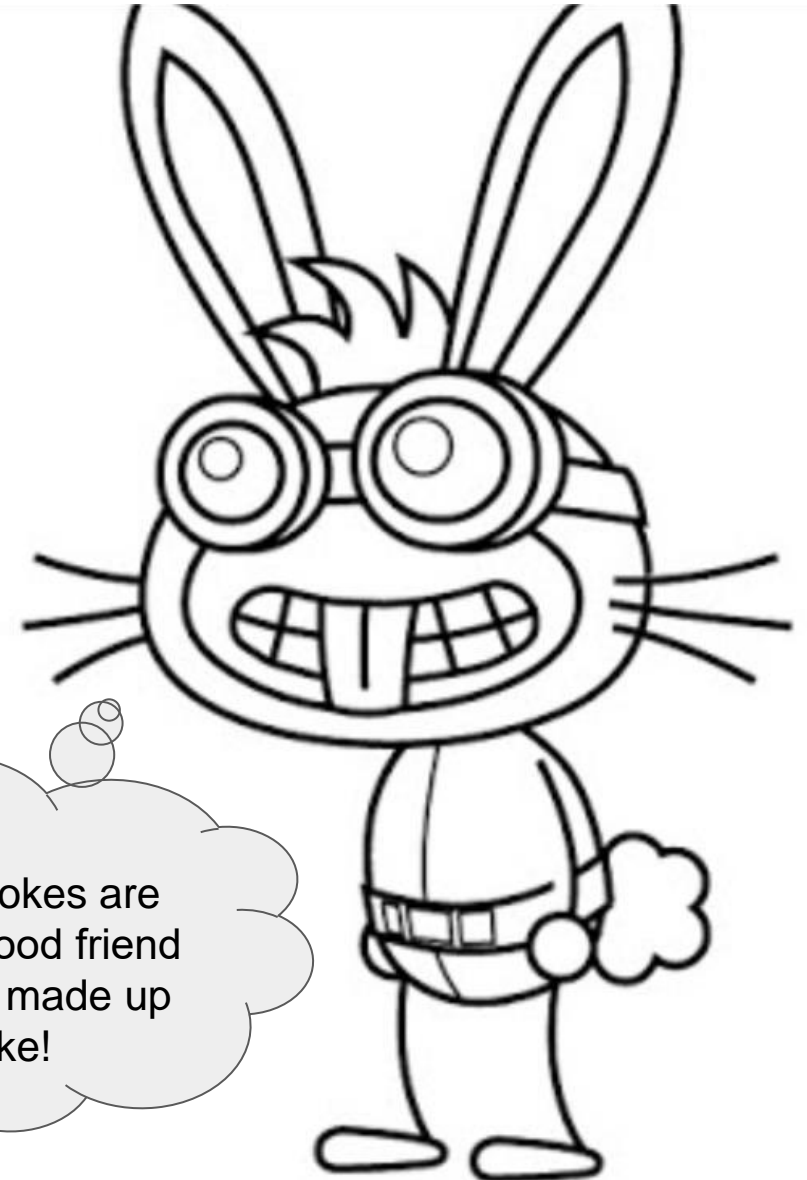

Those first 2 jokes are mine! ...My good friend Invisible Ring made up the Rabbit joke!

MICHAEL

ACTION FORCE

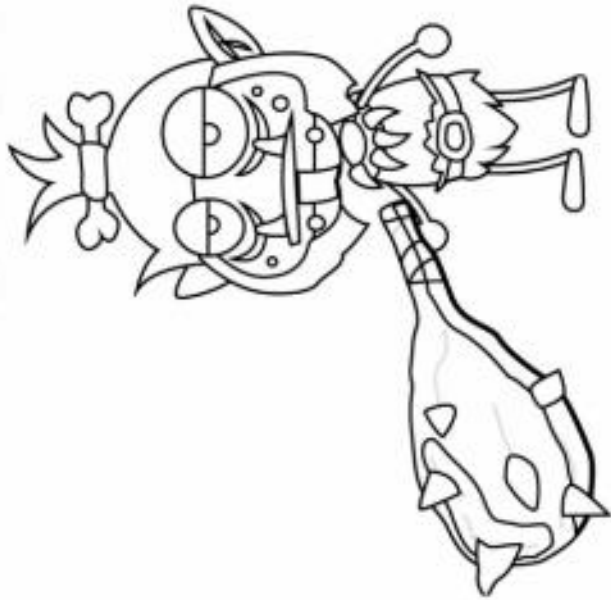

MUTTON CHOPS

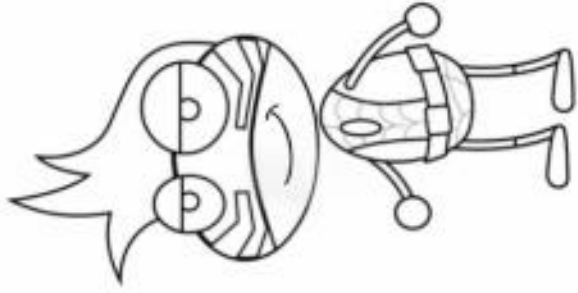

TEEN ARACHNID

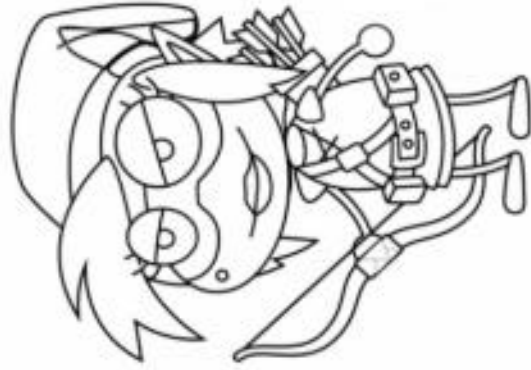

ELF ARCHER

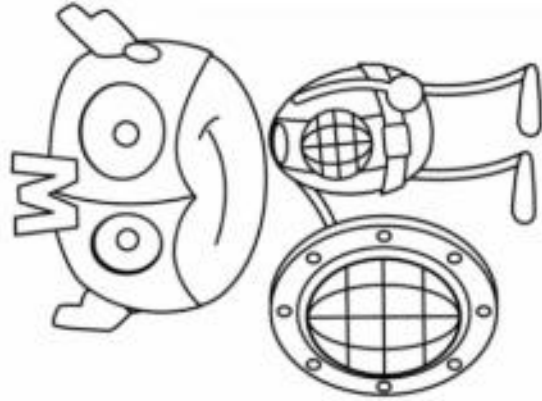

WORLD GUY

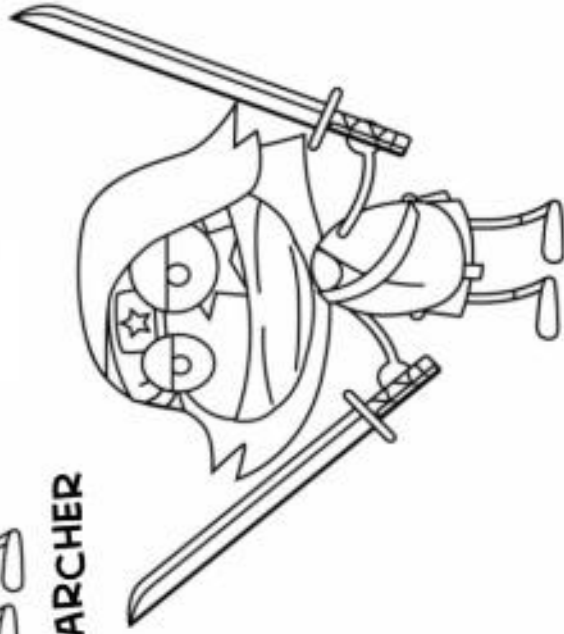

FASHION NINJA

MICHAEL

ACTION FORCE

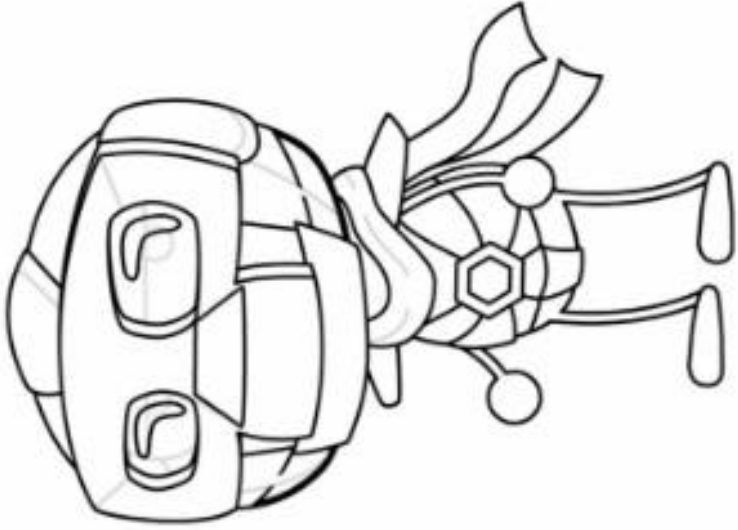

GOLDFACE

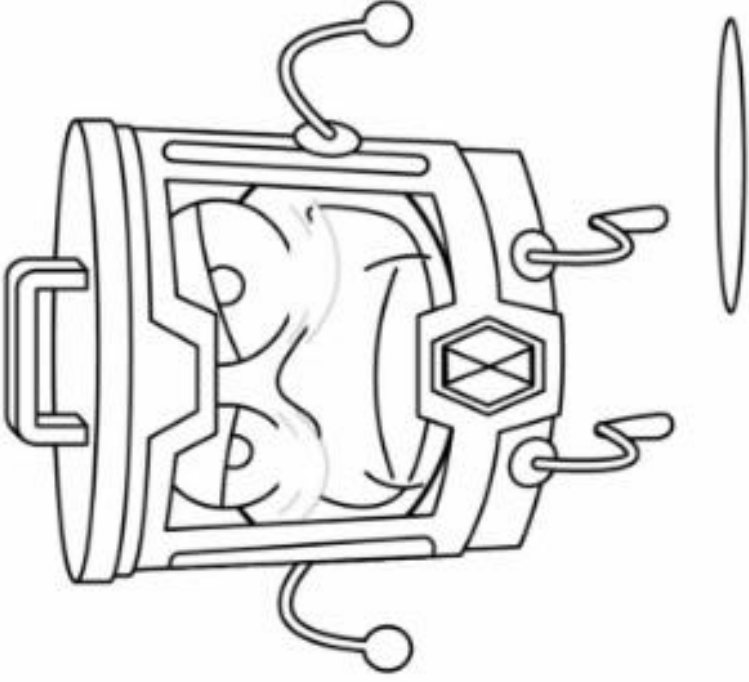

TRASH COLLECTOR

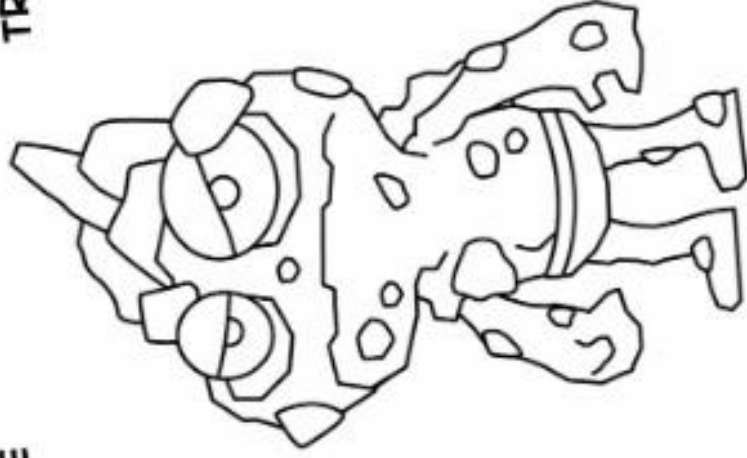

DIRT CLAUDE

NYZTY YVIF
ZJ PFLI
WRMFIZKV?

FILL IN THE STORY!

List the following:

1. Adjective: _____
2. Month: _____
3. Adjective: _____
4. Noun: _____
5. Past tense verb: _____
6. Noun: _____
7. Island: _____
8. Character: _____
9. Place: _____
10. Verb ending in -ing: _____
11. Number > 1: _____
12. Plural Noun: _____
13. Past tense verb: _____
14. Body part: _____
15. Verb: _____
16. Adjective: _____
17. Past tense verb: _____
18. Mode of transportation: _____
19. Body part (plural): _____
20. Emotion: _____
21. Past tense verb: _____
22. Adjective: _____
23. Adjective: _____
24. Noun: _____
25. Past tense verb: _____
26. Past tense verb: _____
27. Verb ending in -ing: _____

IT WAS A _____ adjective _____ month _____ MORNING IN POPTROPICA. I WAS _____ adjective _____ FOR MY NEXT ADVENTURE! I GRABBED MY _____ noun _____ AND _____ past tense verb _____ OUT OF THE CLUBHOUSE. IMMEDIATELY, I SAW THE _____ noun _____ LEAVING MAINSTREET. HOW WAS I GOING TO GET TO _____ island _____ NOW?!

ALL OF A SUDDEN I SPOTTED _____ character _____ LEAVING THE _____ place _____ . THEY WERE _____ verb ending in -ing _____ number > 1 _____ plural noun _____ . I _____ past tense verb _____ MY _____ body part _____ TO GET THEIR ATTENTION.

"HEY! CAN YOU _____ verb _____ ME? I'M SO _____ adjective _____ !" I _____ past tense verb _____ .

"SURE, WHY NOT?" THEY REPLIED. "I'M HEADED THAT WAY ANYWAY. WE CAN TAKE MY _____ mode of transportation _____ ."

I COULDN'T BELIEVE MY _____ body part (plural) _____ ! I FELT _____ emotion _____ . HAPPILY, I _____ past tense verb _____ THEM AND TOGETHER, WE SET OFF. THE JOURNEY WAS _____ adjective _____ , BUT _____ adjective _____ .

LUCKILY, WE ARRIVED WITH PLENTY OF _____ noun _____ TO SPARE. I _____ past tense verb _____ MY FRIEND FOR THEIR HELP. THEY _____ past tense verb _____ AT ME BEFORE CONTINUING ON THEIR TRIP. NOW I COULD FINALLY MY ADVENTURE. NOTHING WOULD STOP ME FROM _____ verb ending in -ing _____ THAT MEDALLION!

Find the Missing Dessert Followers!

Level 1 Maze (hard)

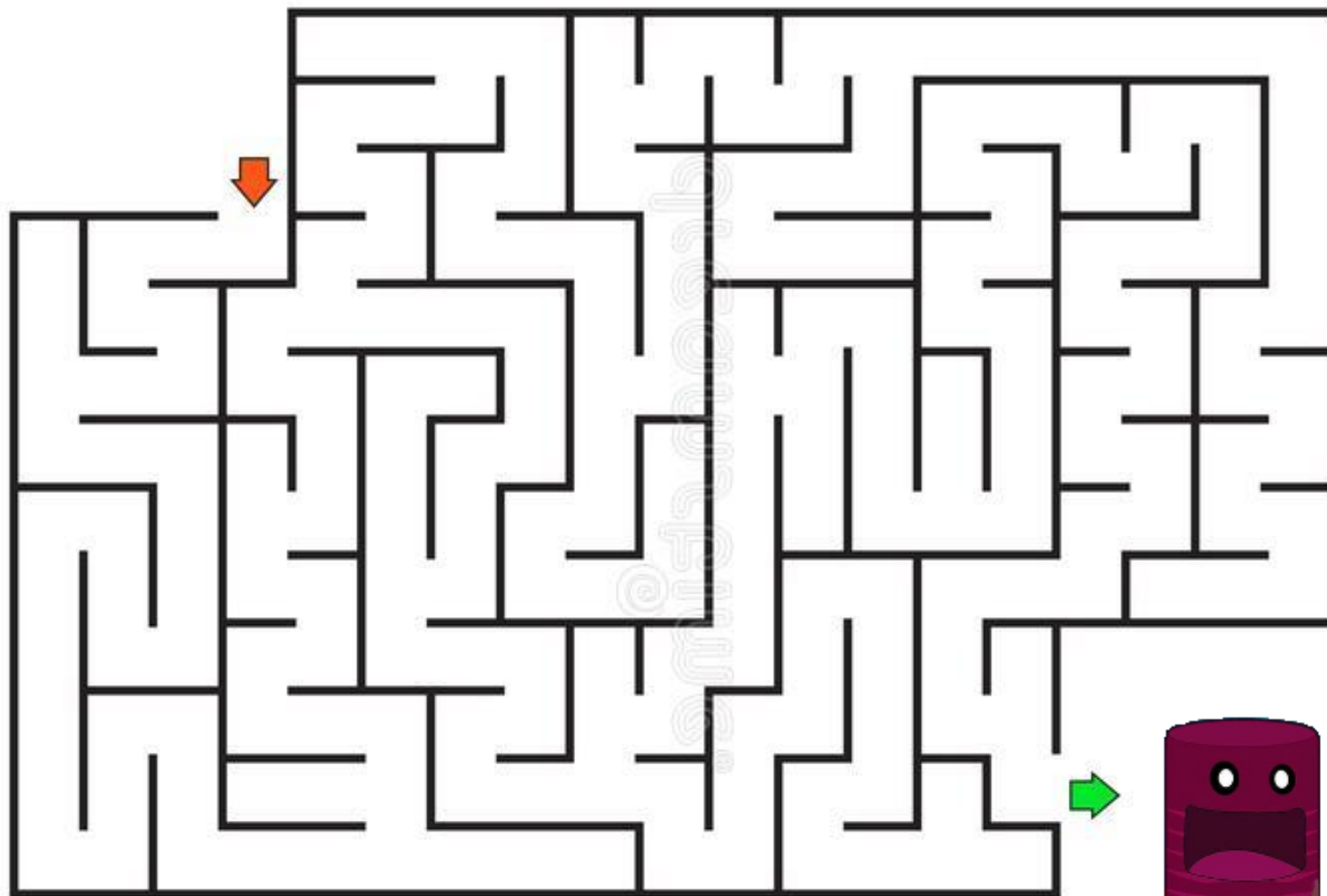

JF
YRGGP
!



Dr. Hare's Corner

Color the funny bunny and share these jokes and poems to your friends and family!

Q: What is jackrabbit jewelry made of?

A: 24-Carrot gold!

You think your human world is rushed? Well, be glad you're not in our rabbit world. Everyone there always tells you to "Hop to it!"

I have the strangest feeling that my friend Invisible Ring had me tell these jokes somewhere before...

Bunnies are the luckiest creatures alive. That's 'cause we've always got our **RABBIT FEET!**

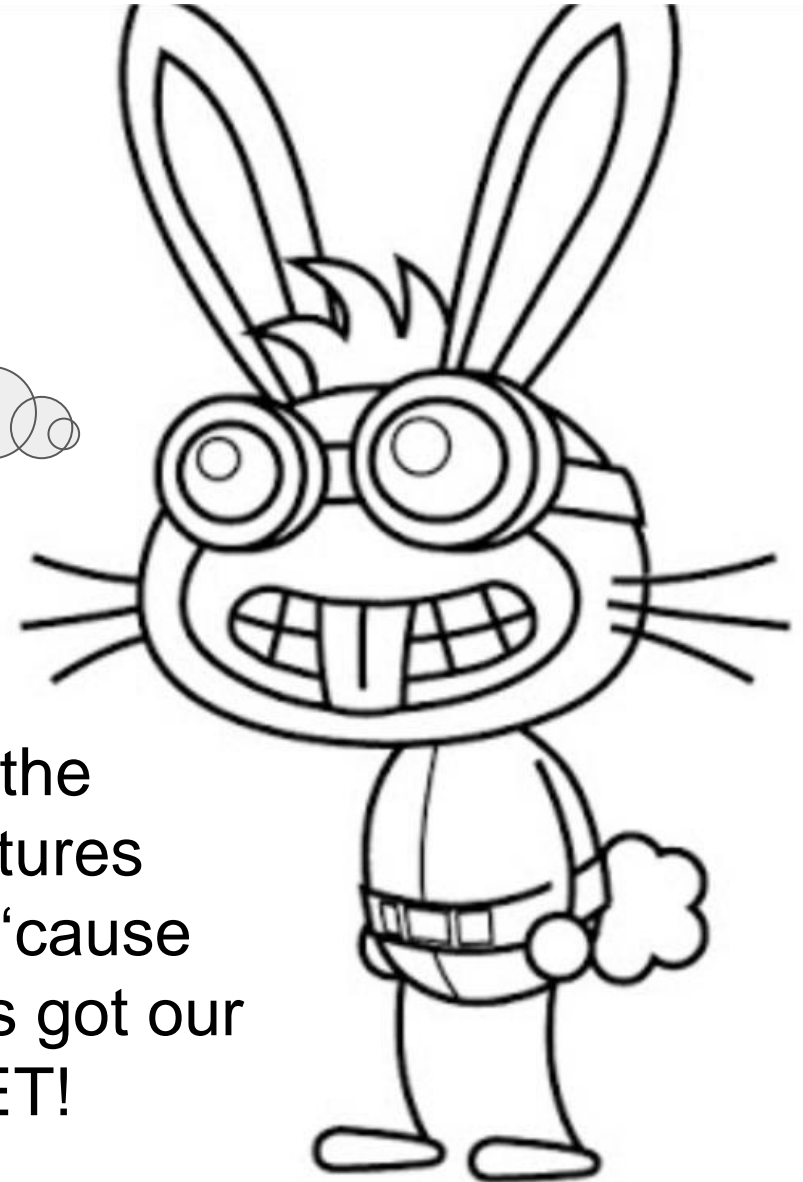



x



+



x



Poptropica



Poptropica

NAME:

DATE:

POPTROPICA WORD SEARCH

CAN YOU FIND THE POPTROPICA-RELATED WORDS IN THE PUZZLE BELOW?

D	R	H	A	R	E	N	F	A	I	R	Y	T	A	L	E
M	P	O	I	N	G	O	E	B	A	M	D	D	Y	A	X
E	T	M	Z	A	Y	R	I	L	U	Y	N	D	M	C	P
D	I	E	H	Y	M	A	A	F	F	T	D	E	L	I	L
A	M	E	L	I	A	B	D	P	U	H	B	H	B	P	O
L	E	E	G	S	C	C	V	I	P	O	O	A	O	O	R
L	T	S	O	L	F	O	E	A	D	L	R	O	S	R	E
I	A	D	O	A	R	R	N	T	P	O	E	T	K	T	V
O	N	N	F	N	I	A	T	A	N	G	H	P	O	P	I
N	G	A	B	D	Y	T	U	K	T	Y	Y	M	A	O	L
C	L	L	A	V	I	V	R	U	S	C	X	I	Z	P	L
E	E	B	L	K	I	X	E	R	O	T	S	L	I	O	A
Q	D	C	L	U	B	H	O	U	S	E	K	B	J	A	I
Q	U	E	S	T	S	G	D	I	L	E	M	P	U	R	N

AMELIA
ADVENTURE

BARON
BLAND
BOSKO

CLUBHOUSE
DR HARE
EXPLORE
FAIRYTALE
GOOFBALL

GRAPPLE PAP
HERO
HOLIDAY
HOME
ISLAND

MEDALLION
MYTHOLOGY
POPTROPICA
QUEST
RUMPEL

STORE
SURVIVAL
TIME TANGLED

Red Dragon Mountain Ninja

Level 2 Maze (harder)

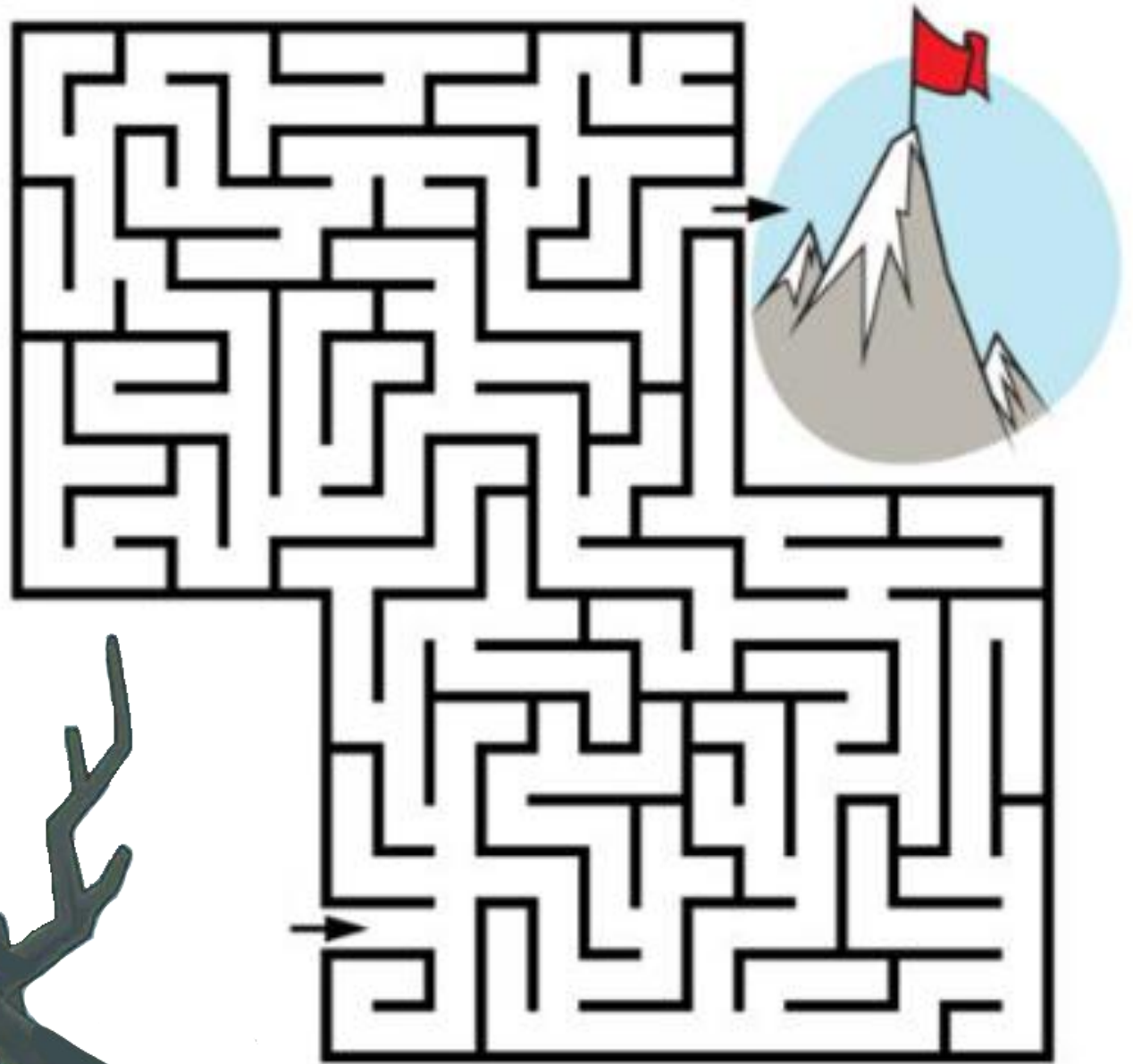

(XFK KYV DRQVJ FWW
KYV NVS WFI WIVV)

Dr. Hare's Corner

Color the funny bunny and share these jokes and poems to your friends and family!

Q: What do you call rabbits in a sandstorm?

A: Dust bunnies!

Q: What exercise do jack rabbits like to do?

A: Jumping jacks!

Cottontails are always running late. Do they lag? More like they "lagamorf"! ...Hop to it, fuzzybunnies!

Hey!
Somebunny is making rabbit puns again!

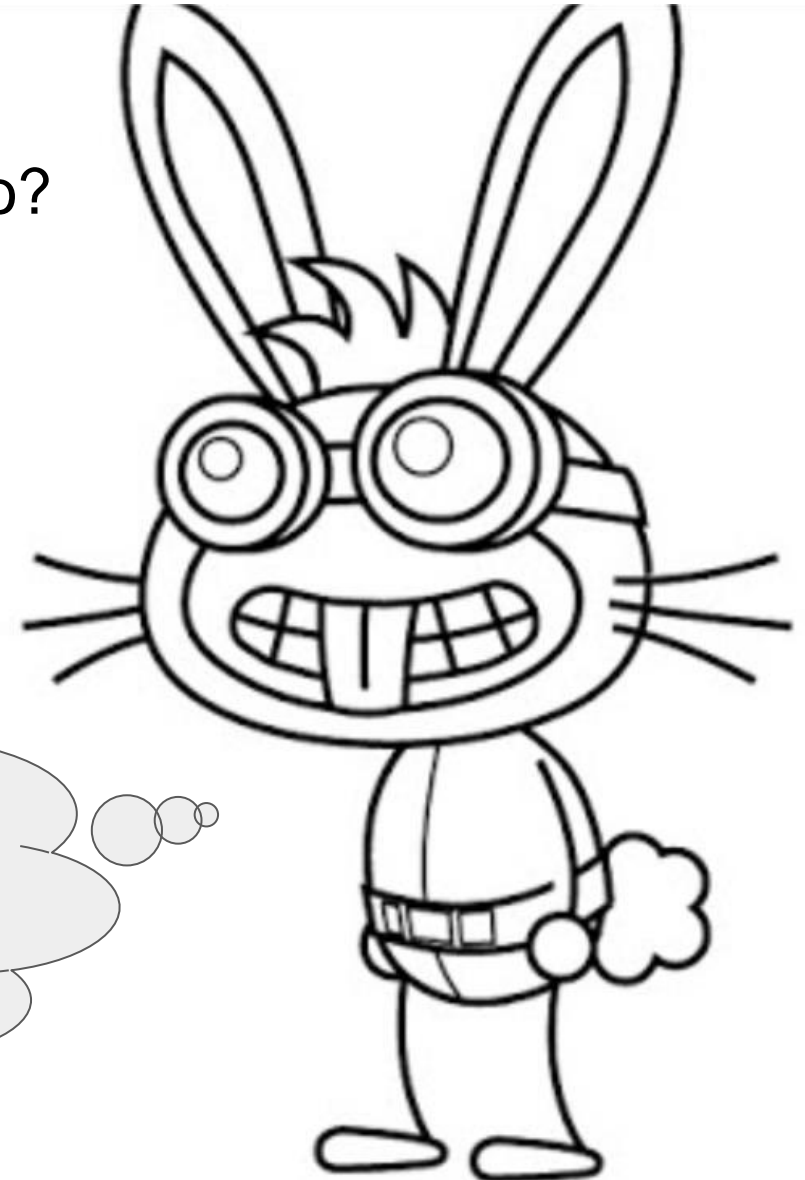

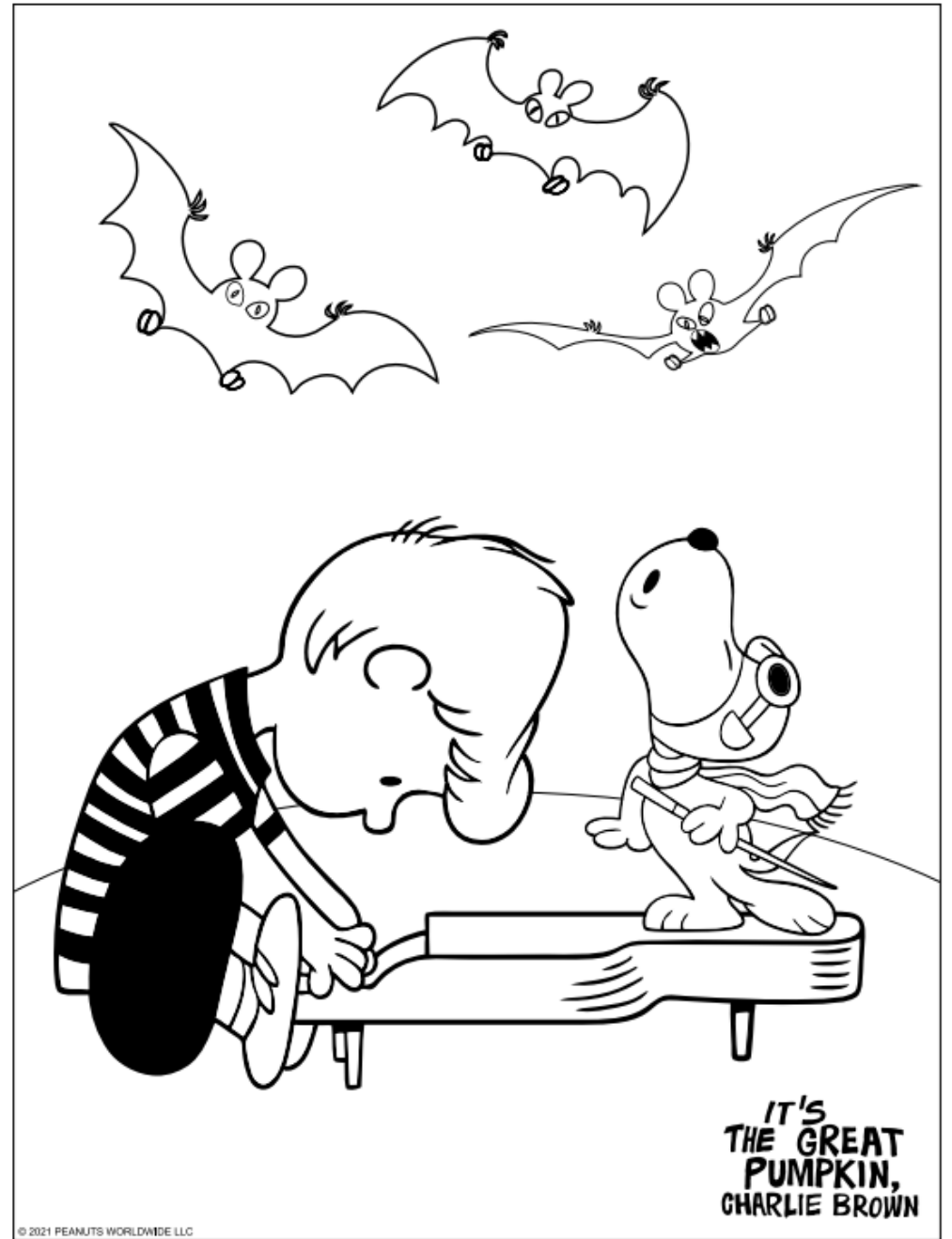

Free Downloadable PDFs from this website-
Click here for more activities. <https://www.peanuts.com/activities/peanuts-coloring-sheets>

Free Downloadable PDF from this website-
Click here for more activities. <https://timmyfailure.com/fun-stuff/>

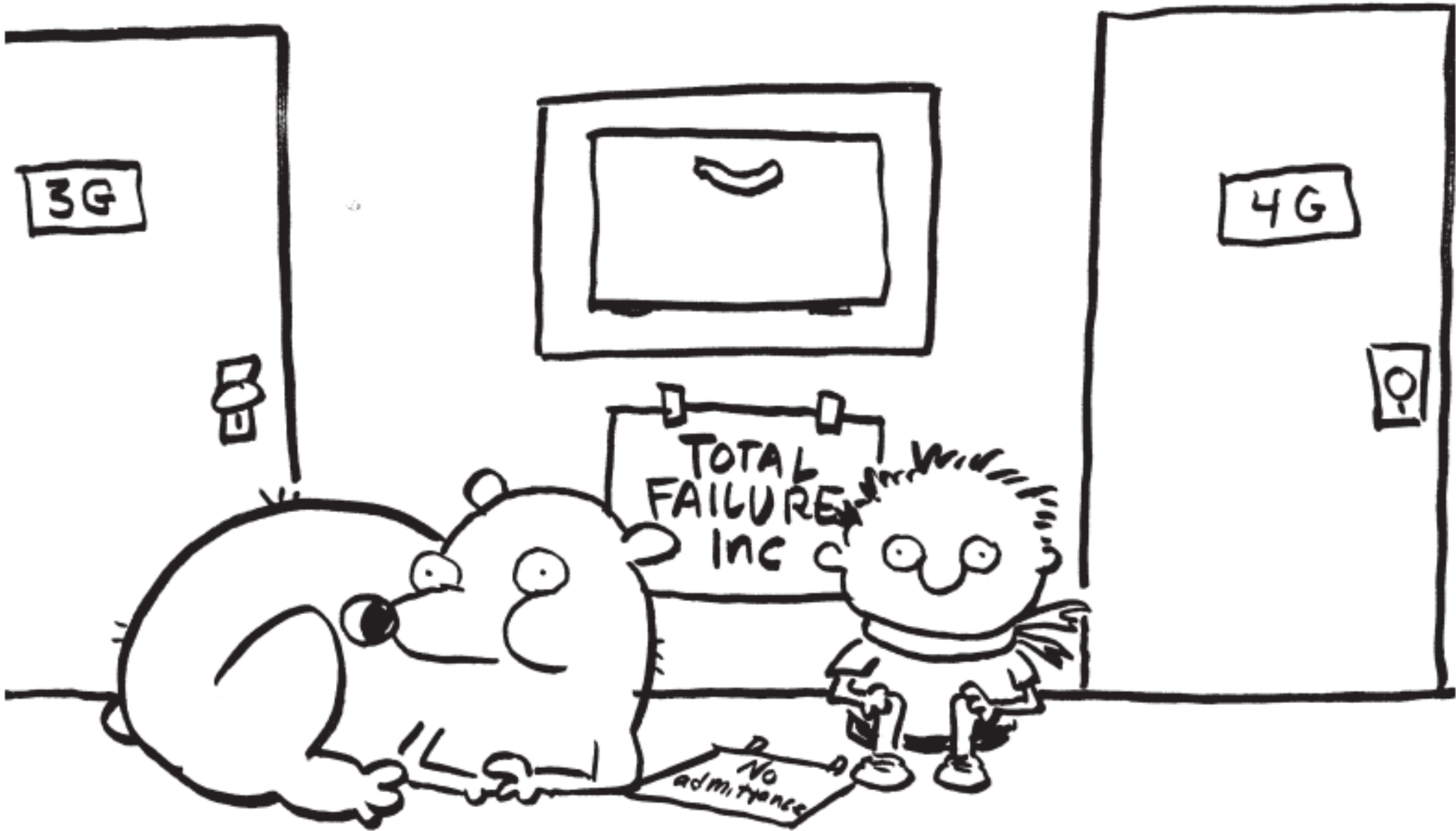

TIMMY FAILURE

Illustration copyright © 2012 by Stephan Pastis

COSMOE, HUMPHREE AND PRINCESS DAGGER

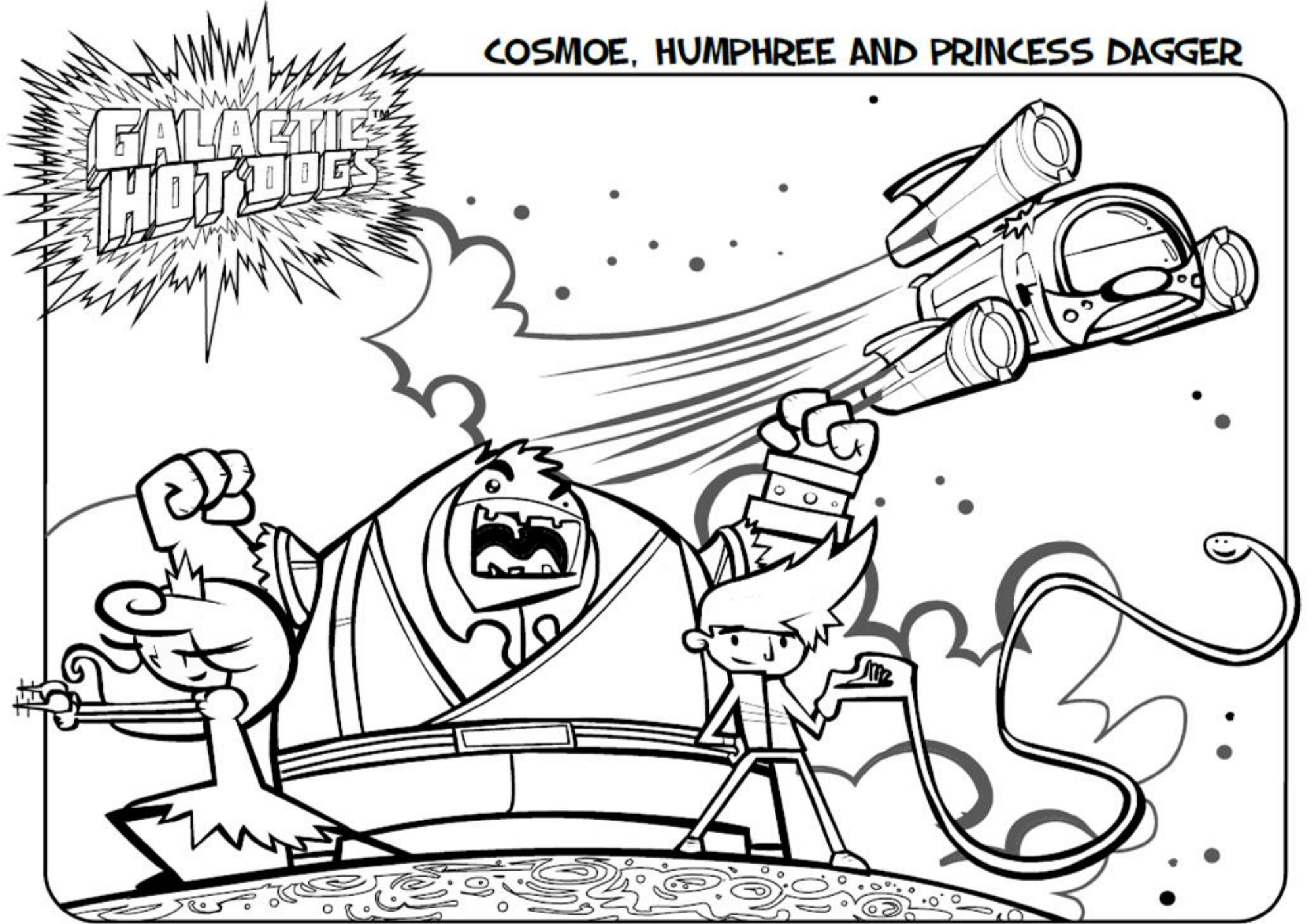

Free Downloadable PDF from this website- [Click here for more activities.](https://content.funbrain.com/books/galactic_hot_dogs_wiener_strikes_back/)

https://content.funbrain.com/books/galactic_hot_dogs_wiener_strikes_back/

INSTRUCTIONS:

Grab a friend and have them guess the letters of the mystery word. If they guess a right letter, put it in the dashes below. (EX: If there's a **Z** on each end of the word, put both the **Z**'s in their appropriate places!)

But if they guess a wrong letter, cross it out of the letter chart and draw your friend in the jail box, bit by bit!

1. Draw their head
2. Their body
3. Their arm
4. Their other arm
5. Their leg
6. Their other leg
7. Draw the jail bars and lock your friend up in jail!

GO TO JAIL

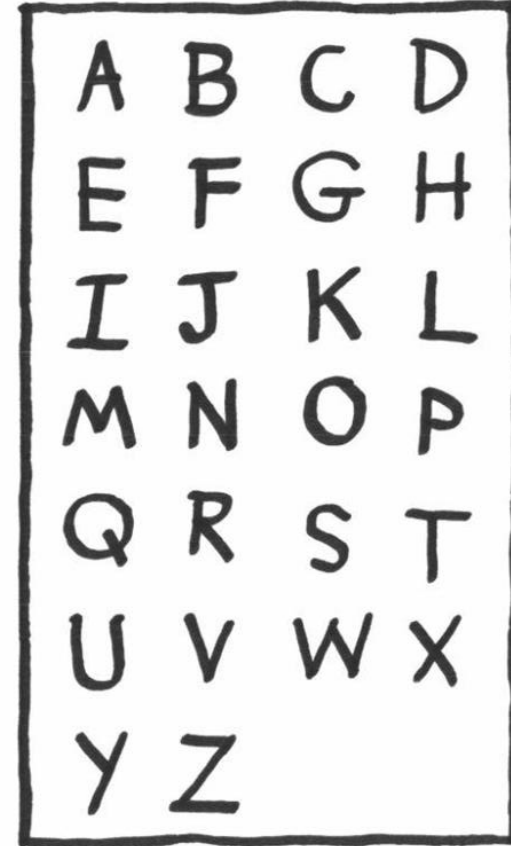

Mystery Word: JKRIJKIZBVI

...If your friend solves the puzzle, they win. But if you can get your friend in jail first, you win. **Don't forget to share the answer with your friend afterwards!**



Labyrinth of the Minotaur



Level 3 Maze (Ouch)

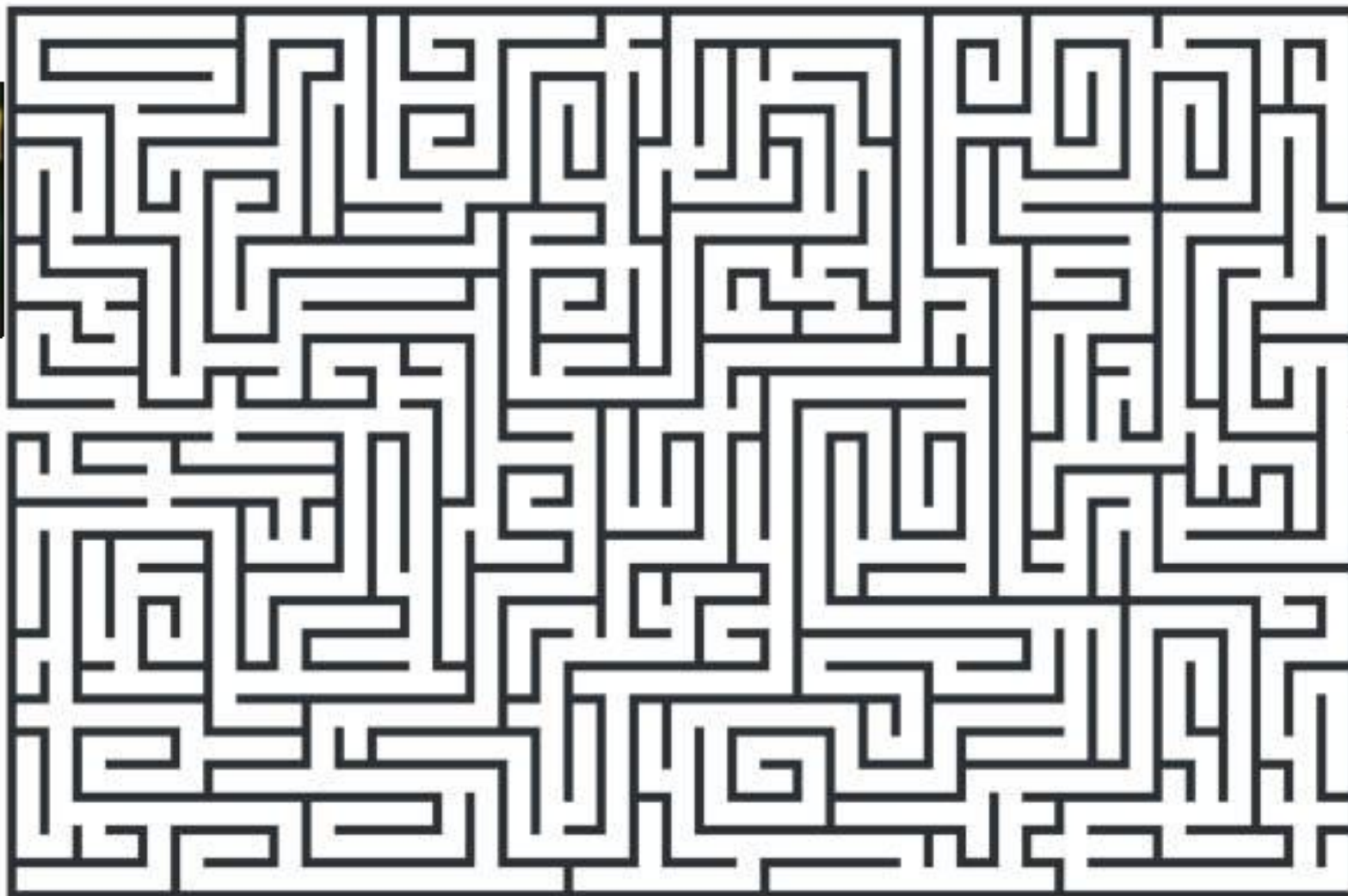

Dr. Hare's Corner

Color the funny bunny and share these jokes and poems to your friends and family!

Are you thinking about checking your hare again? What is it with you people and Hare-dos? Always worried about hare clubs and saying 'Hare today, gone tomorrow'! I bet you hare-brained hareballs hadn't realized we got harrier situations than hare! Look at us bunnies! We're full of hare, but do we care?

...What? I'm free to say whatever I want here! That's why it's called FREE VERSE!

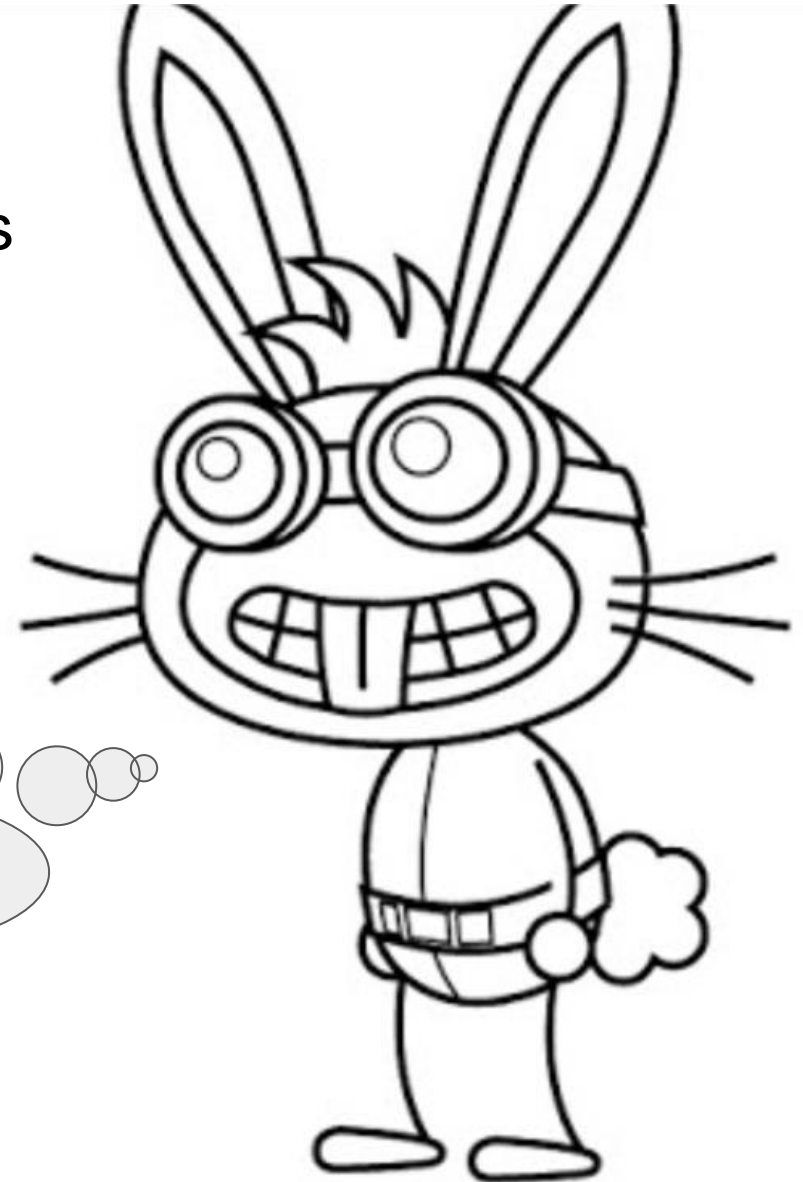

Create Your Own Poptropican! **VO: PFL REU DV!**

What kind of sweaters do they have on? What does their hair look like? ...Draw and color these Poptropicans any way you want, or grab a friend and create them together!

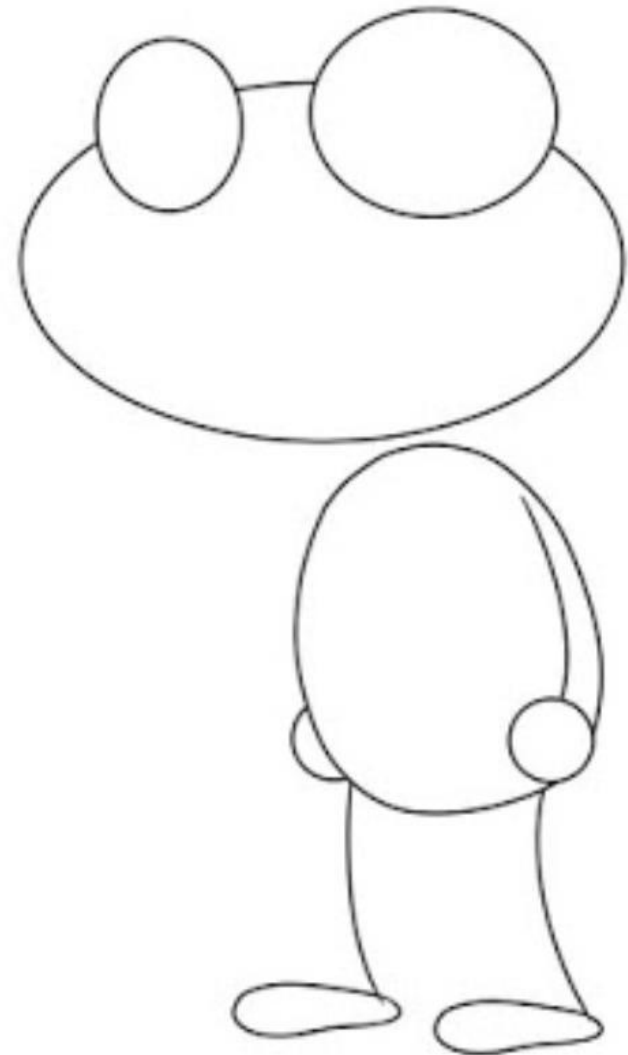
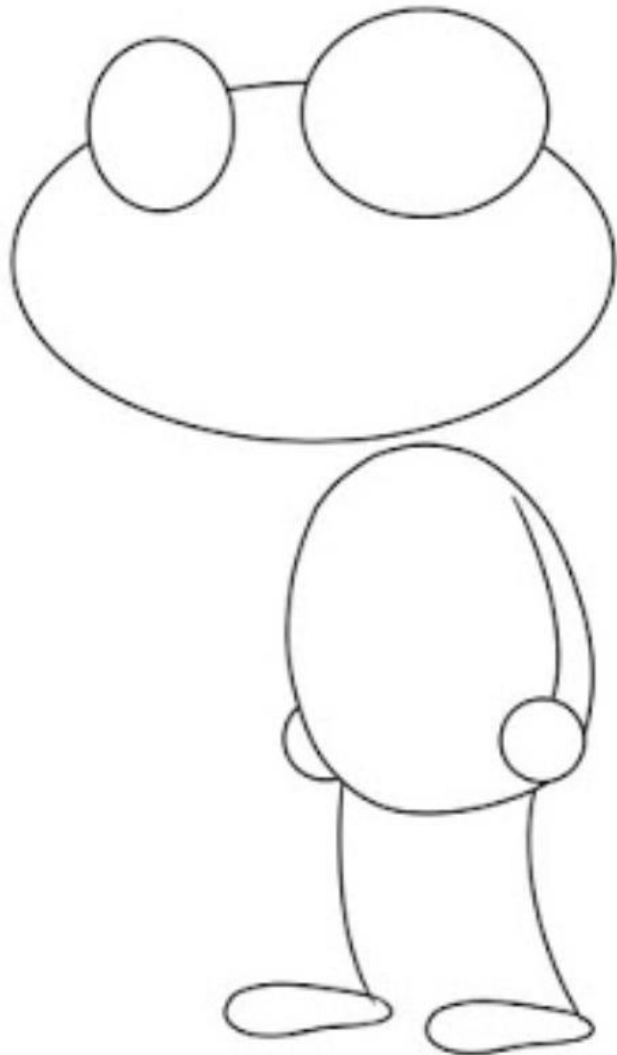

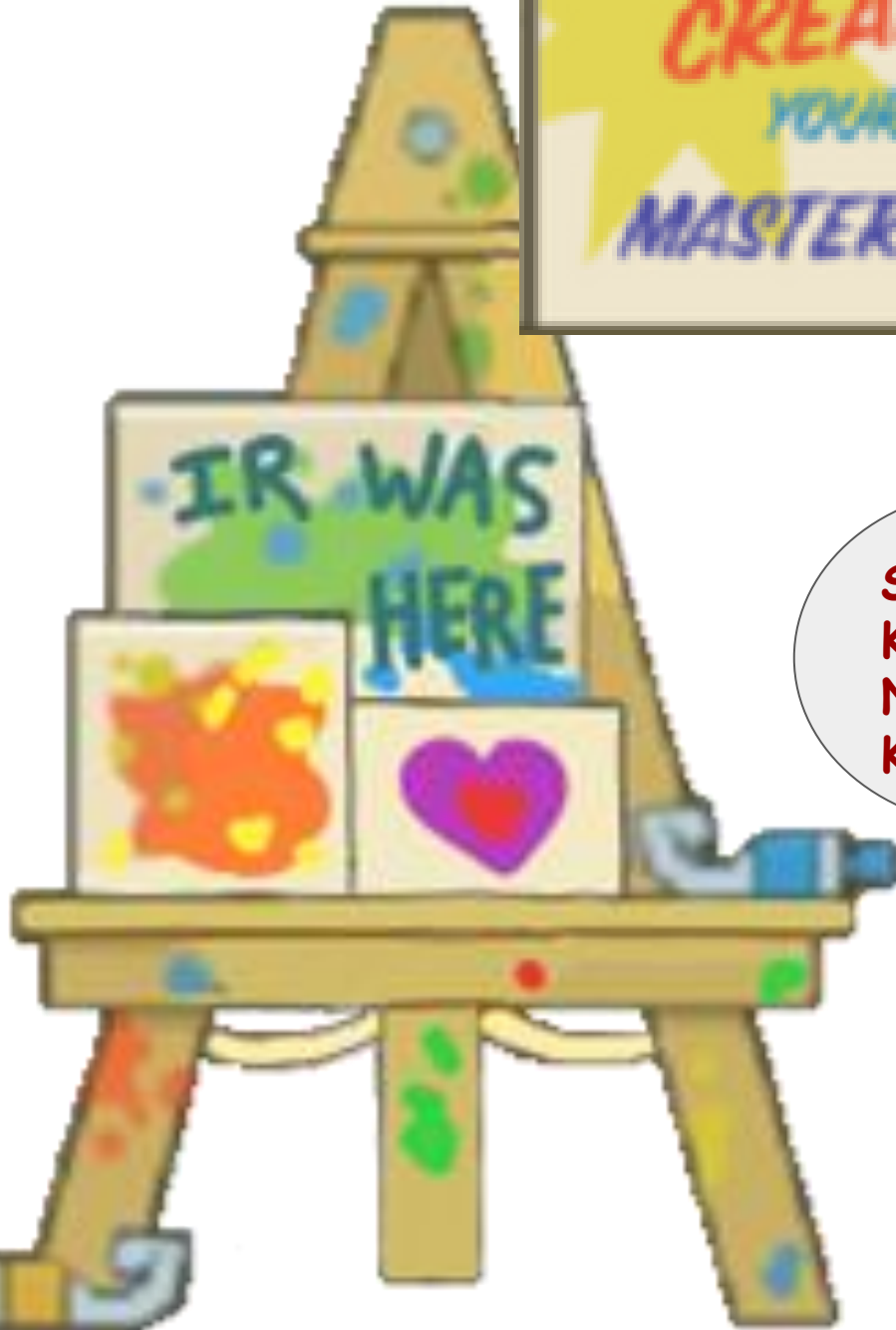
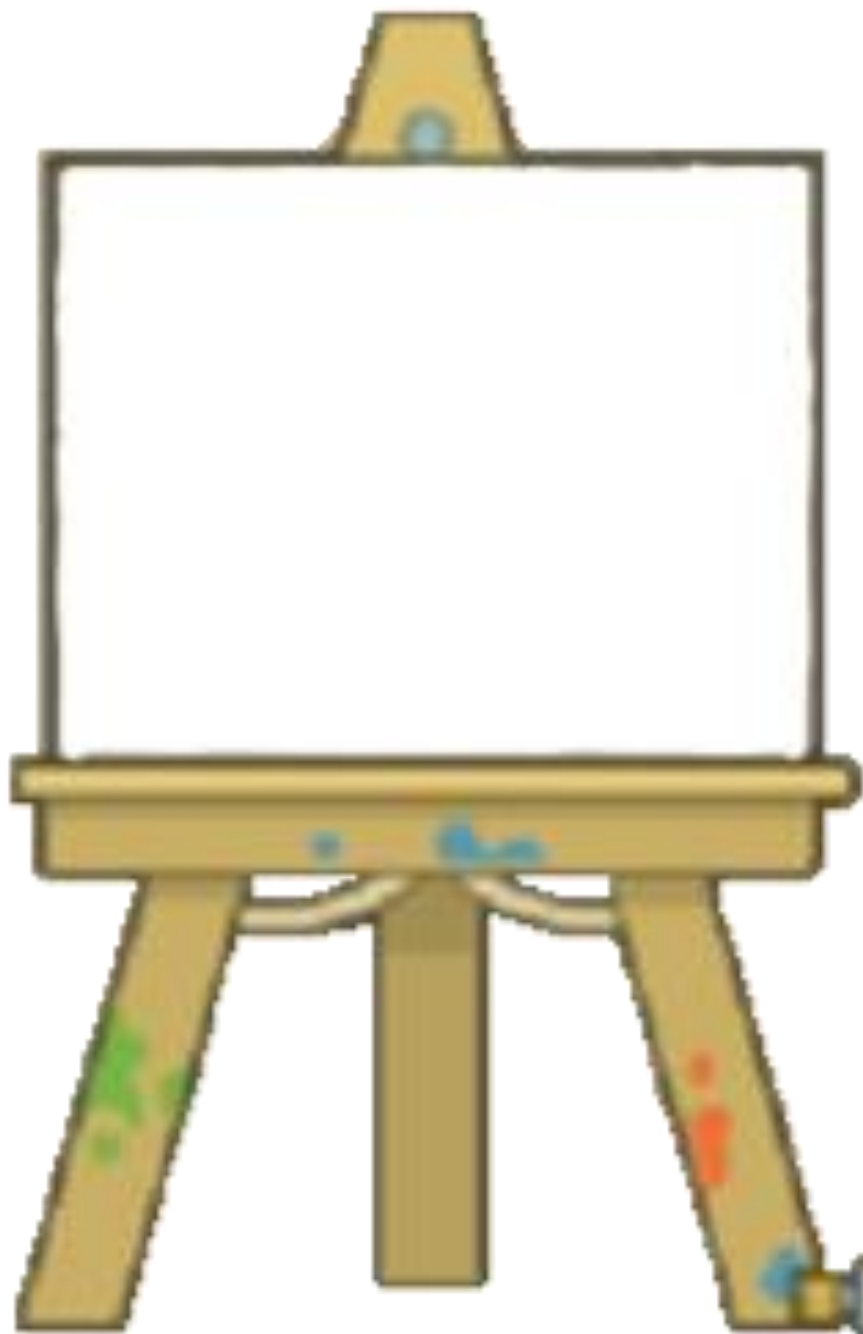

CREATE
YOUR OWN
MASTERPIECE

SLK UFEK
KYV SCRTB
NZUFN
KRBV ZK!

Create Your OWN GO TO JAIL

YREXDRE VOGVIKJ SVNRIV!

Make up your OWN mystery word or sentence and draw all the blank spaces for it below!

Then see if you can throw your friends in jail THIS time!

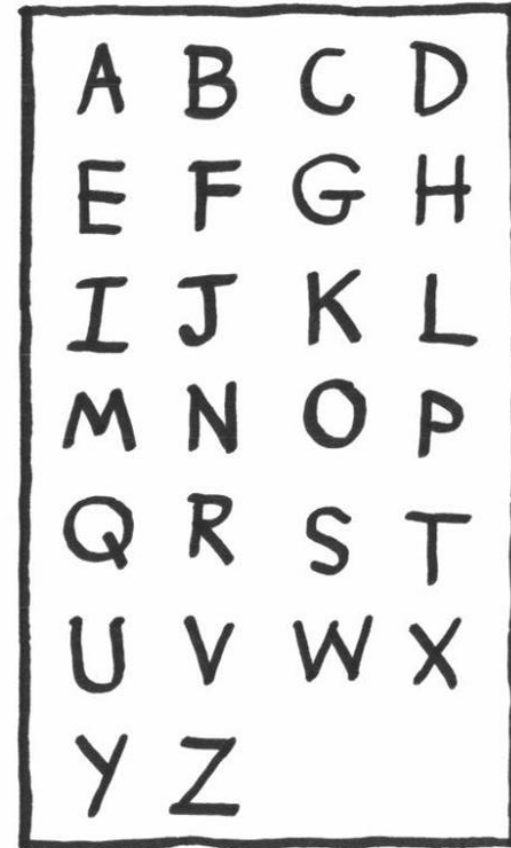
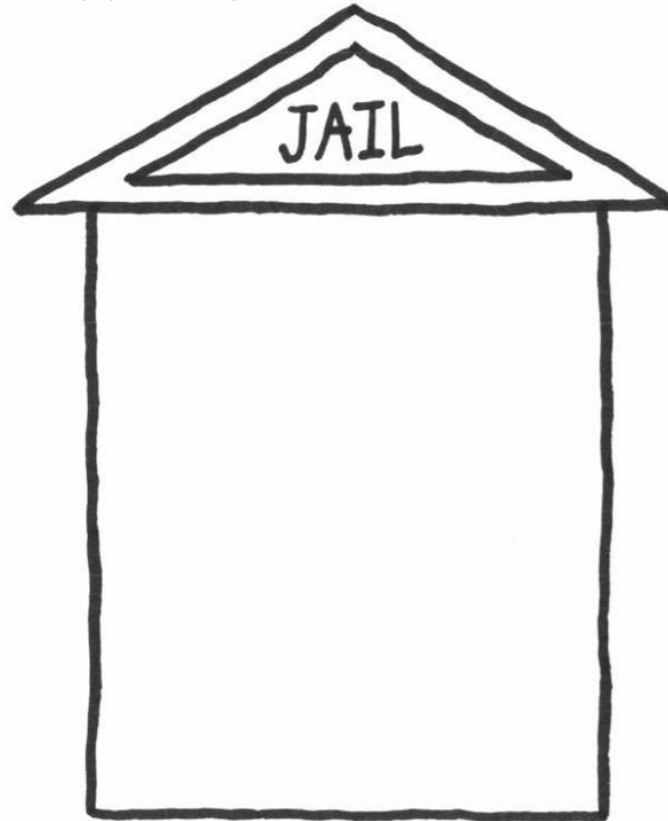

LUNAR COLONY

CODEBREAKER!

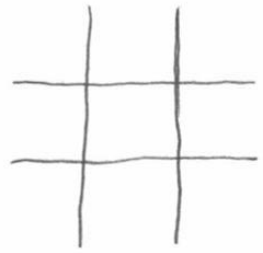

A	B	C
D	E	F
G	H	I



	J	
K		L
	M	

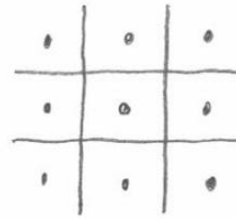

N	O	P
Q	R	S
T	U	V

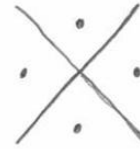

	W	
X		Y
	Z	

**KFFB DV DFEKYJ KF SIVRB
KYZJ RETZVEK TFUV WFI PFL.
...You're welcome!**

Decode the message on these pages!



Invisible Ring's Secret Message:

770 57077 00
00700777 77
00000. >000 07
770770777!

Dr. Hare's Corner

Color the funny bunny and share these jokes and poems to your friends and family!

Get to the root of the sit-uation,
To find Dr. Hare's top secret sta-tion.
Ya gotta find the card keys and all the carrots,
To save the good ol' island of 24 Carrot!

(...And THEN what do you do?)

Then ya find a crazy rabbit like Dr. Hare,
But I better warn you that ya better beware!
He's the craziest villain we ever had,
But if you just ain't careful, he's GONNA BE MAD!

...So, good luck!

-The Bunny Ain't Funny
By Invisible Ring

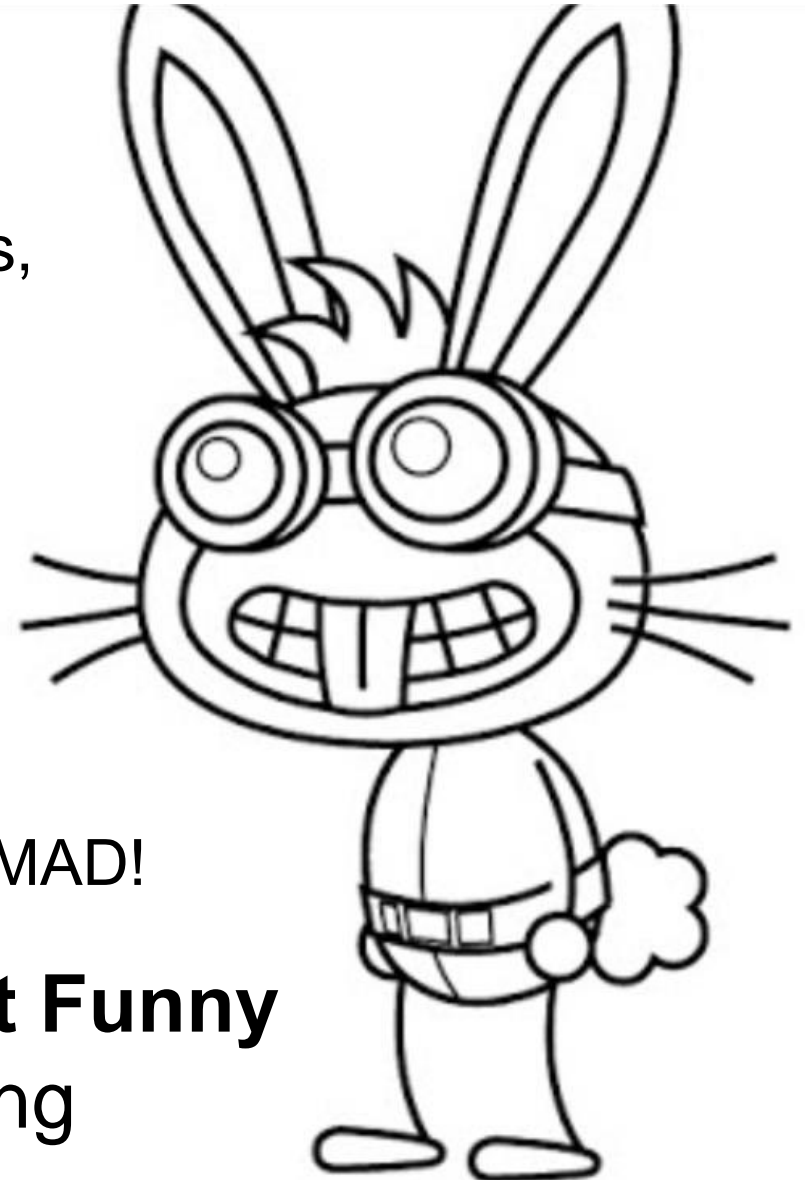



SECRET MESSAGE

<https://www.poptropica.com/>

<https://poptropi.ca/>

<https://www.magictreehouse.com/>

<https://www.funbrain.com/books>

https://www.zazzle.com/store/official_poptropica

...For even MORE adventure and activities from Poptropica and its sponsors, Simply follow the links above or **NXVI OCZ LM XJYZ.**

...Or you can just print out another one of these activity books. -Either way, you win!

-Write your decoded message on this page! →

Use your
Spy Island
decoder to
decode the
secret
message!

Key: **H** = **M**

